

AMPEX

OWNER'S REFERENCE MANUAL



Concerto

HOME MUSIC SYSTEM

SERIES 5200

AMPEX

Welcome to the growing family of music lovers whose discriminating tastes have found expression in the ownership of an Ampex console. This manual has been prepared so that you may realize the full potential of the quality features engineered into your console. It is suggested that you first read the manual carefully, operating the controls to become familiar with their operation and function.

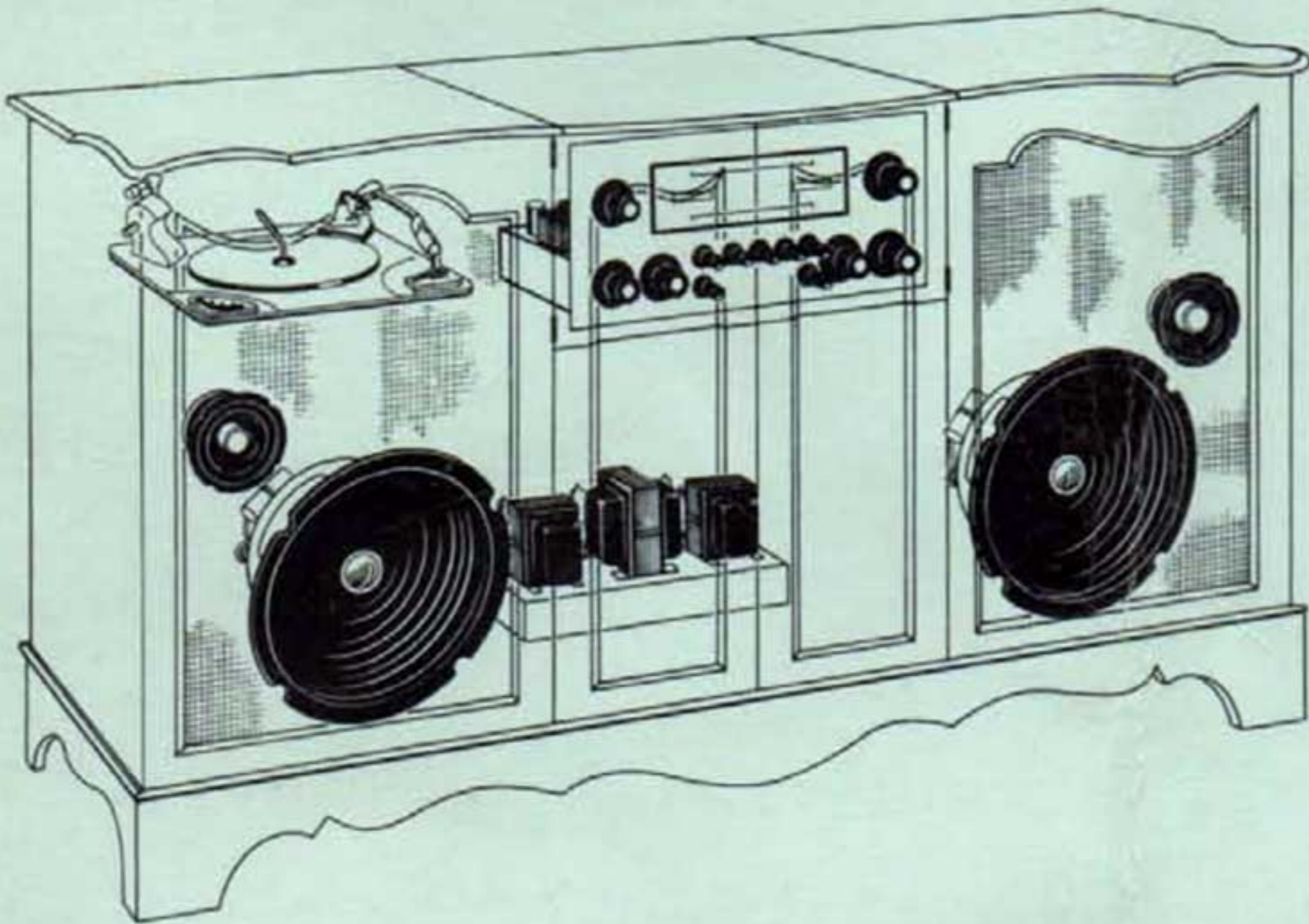

WARRANTY REGISTERED _____ (DATE) _____ 196 _____

Concerto

HOME MUSIC SYSTEM

what it contains:

what it does:

how to operate it:

engineering considerations:



Stereo Center

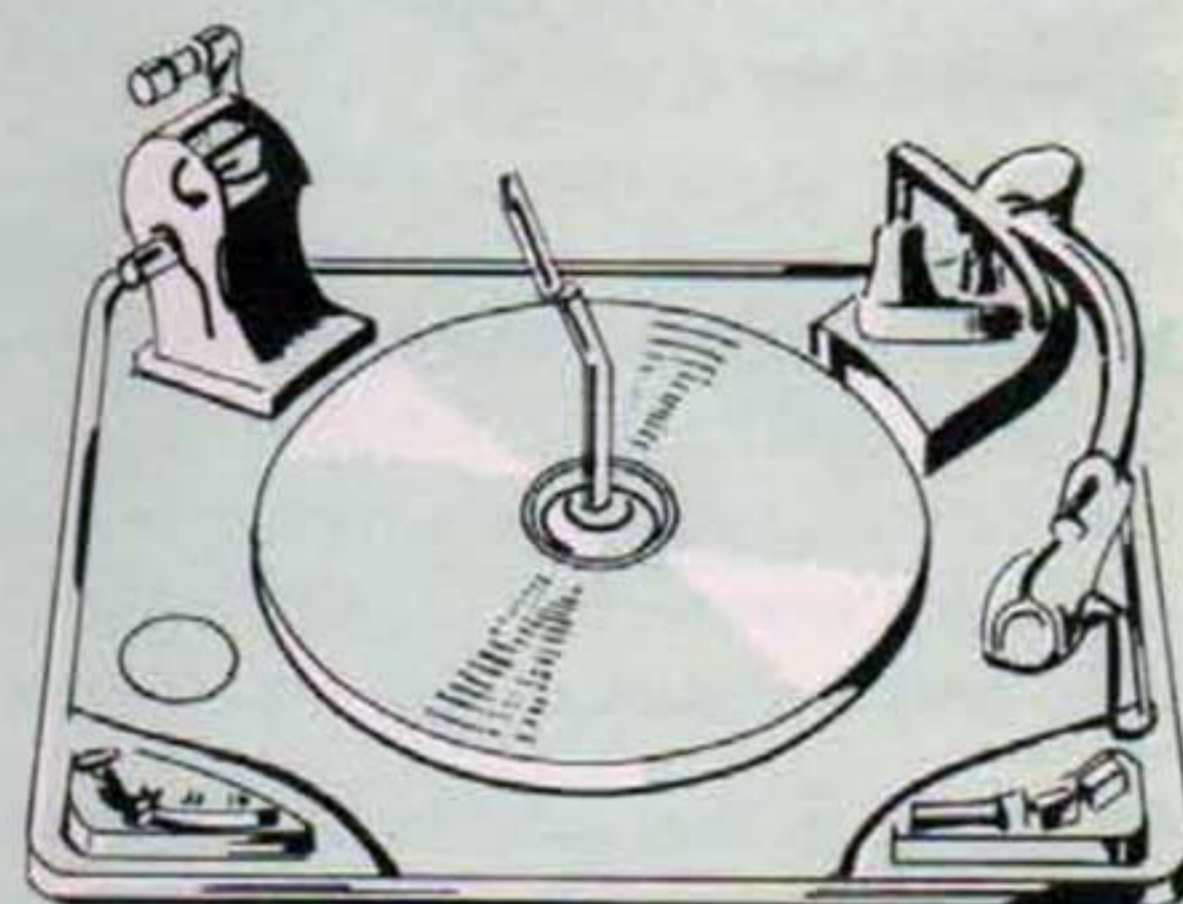

Stereo Phono Player

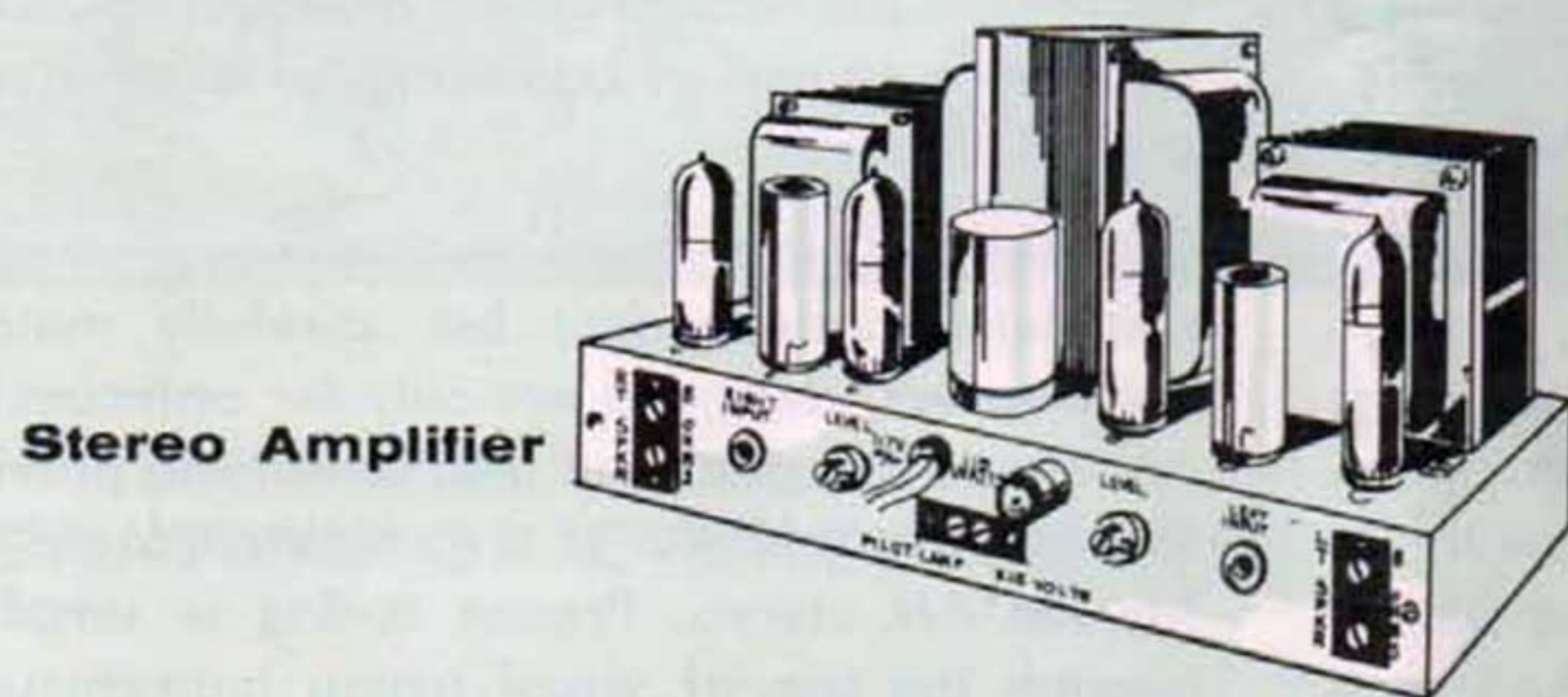

Stereo Amplifier

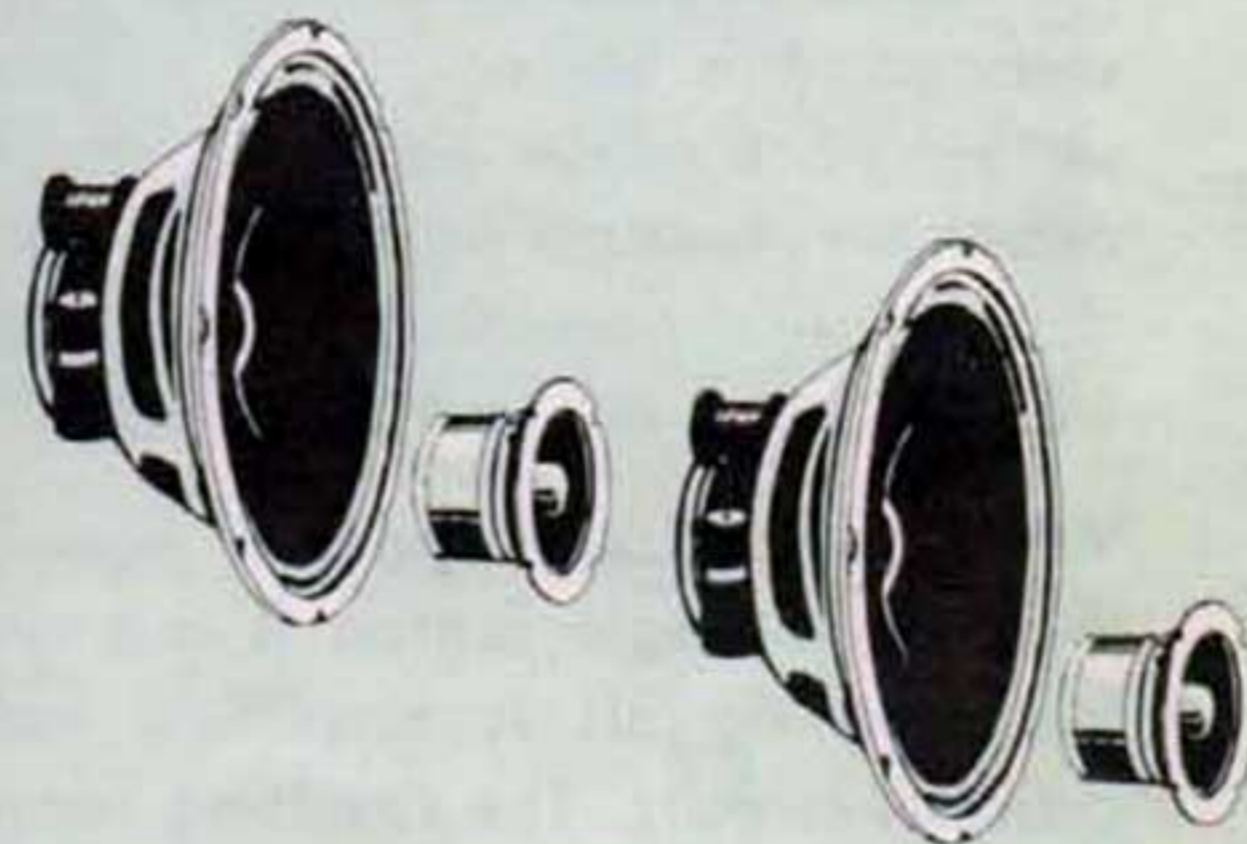

Matching Speaker System

• PLAYS AM
RADIO PROGRAMS

• PLAYS FM
RADIO PROGRAMS

• PLAYS STEREO
RADIO PROGRAMS

• PLAYS MONOPHONIC
RECORDS

• PLAYS STEREO
RECORDS

TO TURN CONSOLE ON

SEE PAGE 5

FUNCTIONAL DESCRIPTION OF STEREO CENTER

SEE PAGE 4

OPERATION OF STEREO CENTER

SEE PAGE 5

STEREO PHONO DESCRIPTION, OPERATIONAL FEATURES

SEE PAGE 6

"HOW-TO-DO-IT TECHNIQUES"

SEE PAGE 7

OPERATING CONSOLE IN CONJUNCTION WITH OTHER COMPONENTS

SEE PAGE 8

SPECIFICATIONS

SEE PAGE 9

SCHEMATIC CIRCUIT DIAGRAM OF STEREO CENTER

SEE PAGE 10

SCHEMATIC CIRCUIT DIAGRAM OF STEREO AMPLIFIER

SEE PAGE 11

OWNER'S WARRANTY

SEE PAGE 11

AMPEX STEREO CENTER

COMBINING THE FUNCTIONS OF STEREO TUNER AND AUDIO CONTROL

The Ampex Stereo Center provides a convenient grouping, on a single panel, of all the controls necessary to maximum stereo listening enjoyment from any source. Whether the stereo source selected is from magnetic tape, stereo phono, or the Stereo Center's own integral Stereo radio tuner, the control functions which are provided automatically assure the proper matching, equalization, and balance of the input signals.

As shown in the functional diagram, the desired signal source is determined by pushbutton selection. If a monophonic (single channel) signal is selected, the Stereo-Single button is depressed so that each of the amplifier/speaker systems receives an identical input, and the resulting reproduced sound appears to come from a point midway between the two speakers.

When stereo (dual channel) signals are selected, the Stereo-Single button is out and each of the incoming signals is amplified independently in parallel circuits. The resulting reproduced sound, depending of course upon the nature of the Stereo signals, will appear to originate not between the speakers but *beyond* them, from the same apparent source and direction "heard" by the recording microphones.

The Stereo Center is provided with separate controls for bass and treble response, enabling you to make individual adjustments as required. To accentuate either the "lows" or the "highs," turn the bass or treble control toward the plus sign. To de-emphasize them, turn the controls toward the minus sign.

A separate loudness control is provided for each channel, enabling you to make individual adjustment as desired to compensate for room acoustics or variations in recordings. The loudness controls are mounted on concentric shafts and are friction-coupled to permit setting and maintaining uniform calibration as well as balancing for differences in audio levels.

The Stereo Center's tuner section incorporates two completely independent but carefully matched radio tuners, designed not only for optimum FM/AM stereo reception but also containing provision for the later addition of a multiplex adapter unit for FM/AM stereo. Precise tuning is simplified through the use of visual tuning indicators, the narrow rectangular panels located within the dial face. An automatic frequency control switch is also provided to lock tuning into center of incoming FM signal.

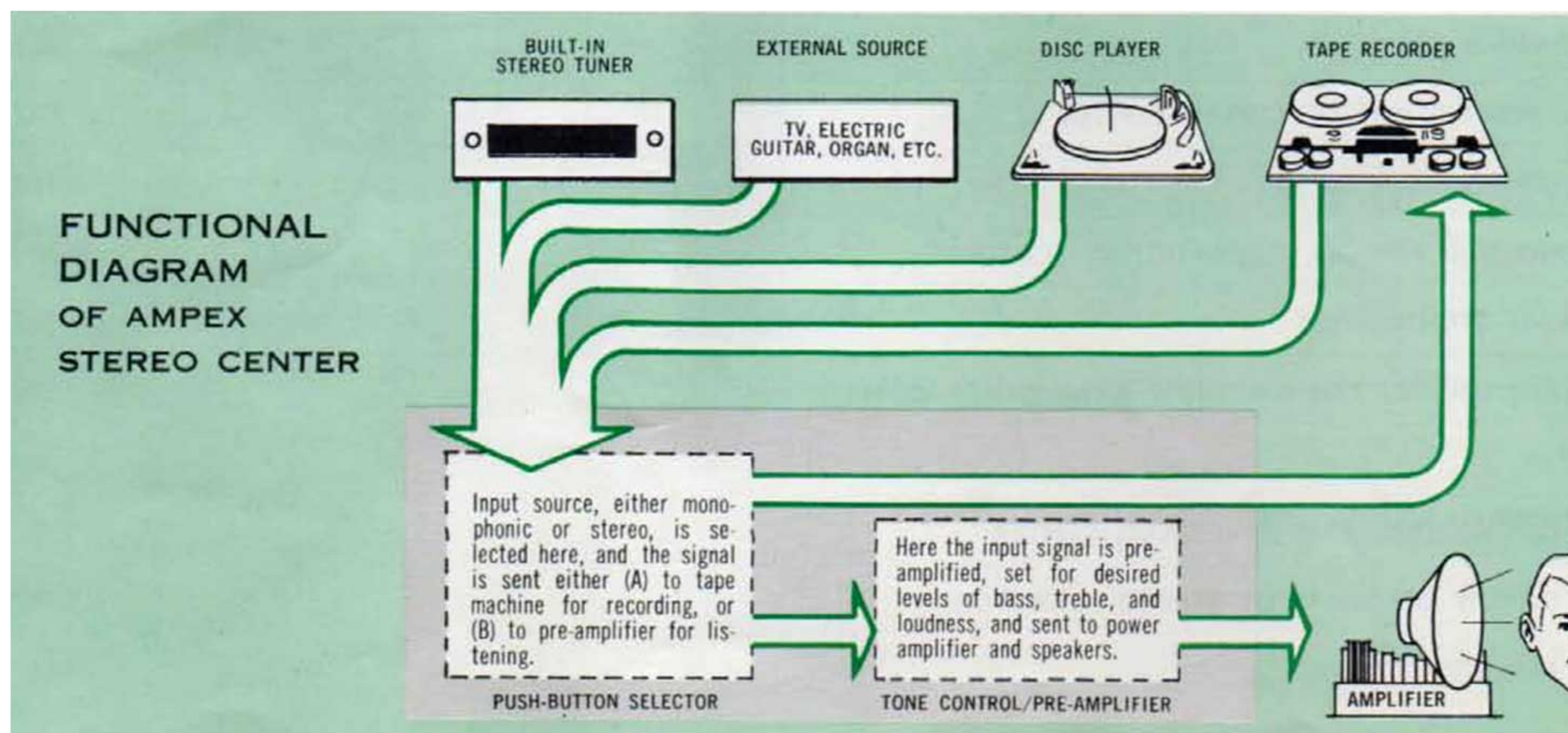



OPERATION OF STEREO CENTER

TURN "ON" by turning control (A) to "on" position. This controls the main power fed to the various components used in the Console.

SELECT DESIRED PROGRAM SOURCE FOR LISTENING by using pushbuttons (D) through (H): (D) for AM radio; (E) for FM radio; (D) and (E) for AM/FM stereo radio; (F) for tape; (G) for phono; and (H) for an external source. If the program is stereo, pushbutton (J) must be out; if monophonic, (J) must be *in* for feeding the signal to both speaker systems. Normally, (K) will be out. If program is to be recorded on tape, (K) will be pushed in after program is selected and tape machine is prepared for recording.

OPERATE SELECTED PROGRAM SOURCE according to the instructions for the selected component, **ADJUST LISTENING LEVELS.** Controls (B) and (C) adjust the loudness level, and should be set at the most pleasing level. The two controls are independent, but are friction-coupled so they will normally turn together. If necessary, balance can be corrected by holding one control while turning

the other. Tone is adjusted as desired by using (L) for bass and (M) for treble. Turning clockwise increases, and counter-clockwise decreases the emphasis of bass and treble tone.

OPERATION OF TUNER. After selecting AM and/or FM for listening, it is only necessary to tune in the desired program. For AM, turn control (N) to desired station as indicated by the pointer position on the AM dial scale. Proper tuning of selected station is indicated by minimum dark area in tuning indicator (P).

For FM, use control (O) for tuning in desired station, and (Q) for indication of proper tuning. Control (A) should be in "on" position while tuning in an FM station. When properly tuned in, switch (A) to "AFC" position, which "locks" the tuning and avoids FM drift.

For AM/FM stereo broadcasts, tune both AM and FM to proper station. The sound level from each station may be different, depending upon distance from your local stations. Use controls (B) and (C) to adjust for proper balance.

STEREO PHONO PLAYER



The automatic record changer in your Ampex console is capable of reproducing all modern stereo and monophonic disc recordings. The pickup arm incorporates a high quality dual-axis magnetic cartridge with diamond stylus, which reproduces microgroove stereo and monophonic discs interchangeably. Features of the record changer include a powerful constant-speed 4 pole motor, extra-quiet heavily weighted turntable, automatic shut-off and fully adjustable pickup arm.

To reject a selection, move the right-hand knob to the REJECT position. To stop the changer before all selections have been played, simply move the lever to STOP position. If this is done while a record is playing, that record will be rejected when changer is again placed in operation.

MANUAL CONTROL

The purpose of the manual control is to disconnect the changing mechanism so that single records can be played as on a transcription turntable. Move the MANUAL-AUTO knob to MANUAL and replace the long record spindle with the short

spindle. The pickup arm will be free to move and you can play the unit as a single record player. At the completion of a record the pickup will rise and return to its rest leaving the turntable revolving. To stop motor and turntable, move the right-hand control to STOP.

SPECIAL NOTE: 45- AND 78-RPM RECORDS

If you plan to use your record changer with 45-rpm records, first pull out the slender record spindle and install the large spindle. Place the seven-inch 45-rpm records over the large spindle and do not lower the record clip. Adjust the speed change knob to "45" and play records as you normally would.

Although the cartridge on the record changer may be used interchangeably with any microgroove record, stereo or monophonic, it would be wise not to use it with 78-rpm records. It is recommended that you use a special cartridge, available at nominal cost in any hi-fi store, for playing 78-rpm records.

TO OPERATE:

6

1. MOVE SPEED CHANGE KNOB TO DESIRED SPEED

2. SET LEVER FOR SIZE OF RECORD TO BE PLAYED

3. PLACE UP TO EIGHT RECORDS ON SPINDLE, AND LOWER CLIP

4. MOVE SWITCH TO "ON"



"HOW-TO-DO-IT" TECHNIQUES

To Play Monophonic (AM or FM) Radio Programs

AM: Set push-buttons as shown in chart at right. Turn the AM radio tuning control **N** to bring the pointer on the upper scale to the approximate station setting desired. The station is precisely tuned in when the dark band in the center of the visual tuning indicator **P** is at its narrowest.

FM: Set push-buttons as shown in chart at right. Turn selector control **A** to "ON." Turn the FM radio tuning control **O** to bring the pointer on lower scale to the approximate station setting desired. Station is precisely tuned in when the dark band in the center of the visual tuning indicator **Q** is at its narrowest point. Now turn control **A** to FM-AFC, which will cause the tuning circuit to lock automatically on to the incoming signal and compensate for any frequency drift.

To Play Stereo Radio Programs: Set push-buttons as shown in chart at right. The AM and FM push-buttons should be depressed simultaneously so that both engage. Turn tuning controls **N** and **O** to proper settings for the AM and FM frequencies of the stations which are broadcasting stereo, tuning for the narrowest gap in the visual tuning indicators. Now release the AM and FM buttons one at a time, and adjust controls **B** and **C** individually to properly balance the two signals, accommodating any possible differences in the station's AM and FM signal strengths.

To Play Monophonic Records: Review page 6; then set push-buttons as noted in chart at right. Release the arm catch, and make certain the plastic extension is in place at the end of the selector arm. Set the speed control knob and size selector for the records being played, and lower the clip so that it secures the records. Move the changer switch to "ON".

To Play Stereo Records: Since the record player in your console will play both monophonic and stereo records interchangeably, the settings and operating procedure are identical with those noted above for playing monophonic records. However, it is possible that some stereo recordings will reproduce more to your satisfaction if you adjust controls **B** and **C** independently to achieve better balance between channels.

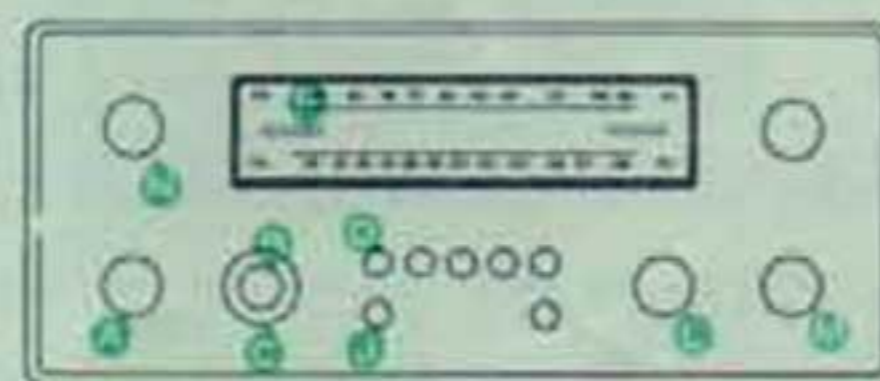

A	On	H	
B	As Desired	J	In
C	As Desired	K	
D	In	L	As Desired
E		M	As Desired
F		N	Tune Station
G		O	Tune Station

ADJUST CONTROLS SHOWN WITH COLORED DOTS
To Play Monophonic AM Radio Programs

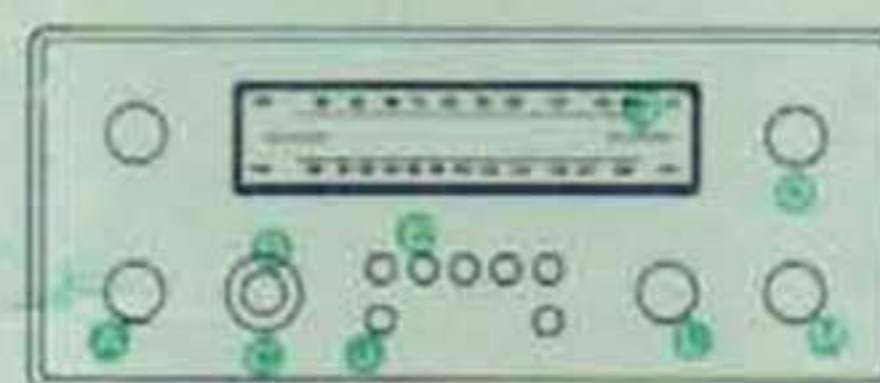

A	On	H	
B	As Desired	J	In
C	As Desired	K	
D		L	As Desired
E	In	M	As Desired
F		N	
G		O	Tune Station

ADJUST CONTROLS SHOWN WITH COLORED DOTS
To Play Monophonic FM Radio Programs

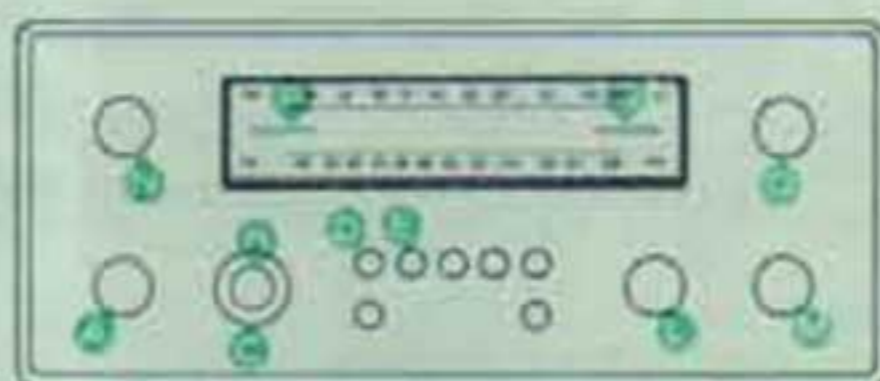

A	On	H	
B	As Desired	J	
C	As Desired	K	
D	In	L	As Desired
E	In	M	As Desired
F		N	Tune Station
G		O	Tune Station

ADJUST CONTROLS SHOWN WITH COLORED DOTS
To Play Stereo Radio Programs

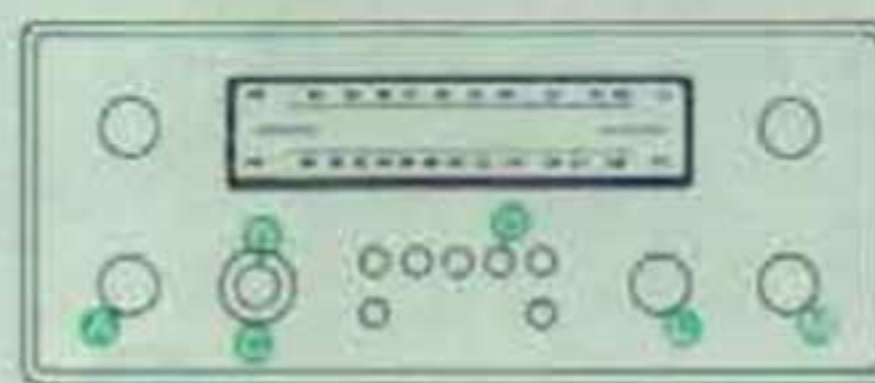

A	On	H	
B	As Desired	J	
C	As Desired	K	
D		L	As Desired
E		M	As Desired
F		N	
G	In	O	
R	On		



ADJUST CONTROLS SHOWN WITH COLORED DOTS
To Play Stereo or Monophonic Records

OPERATING YOUR CONSOLE IN CONJUNCTION WITH OTHER COMPONENTS

Your Ampex console was designed to operate in conjunction with a tape recorder such as the Ampex stereo tape recorder/player, which may be added to your system at any time. With such an addition, cabled into the system as shown in the diagram below, the number of operations you can perform will be greatly multiplied. You'll be able to record as you listen, from monophonic or stereo records and radio programs, as well as recording "live" with microphones. In addition, you'll be enabled to record sound from any external source, such as from your TV, from electric guitar, organ, or other instrument with electronic output. At right is a photograph showing the connector panel, noting the proper connections for use with external inputs.

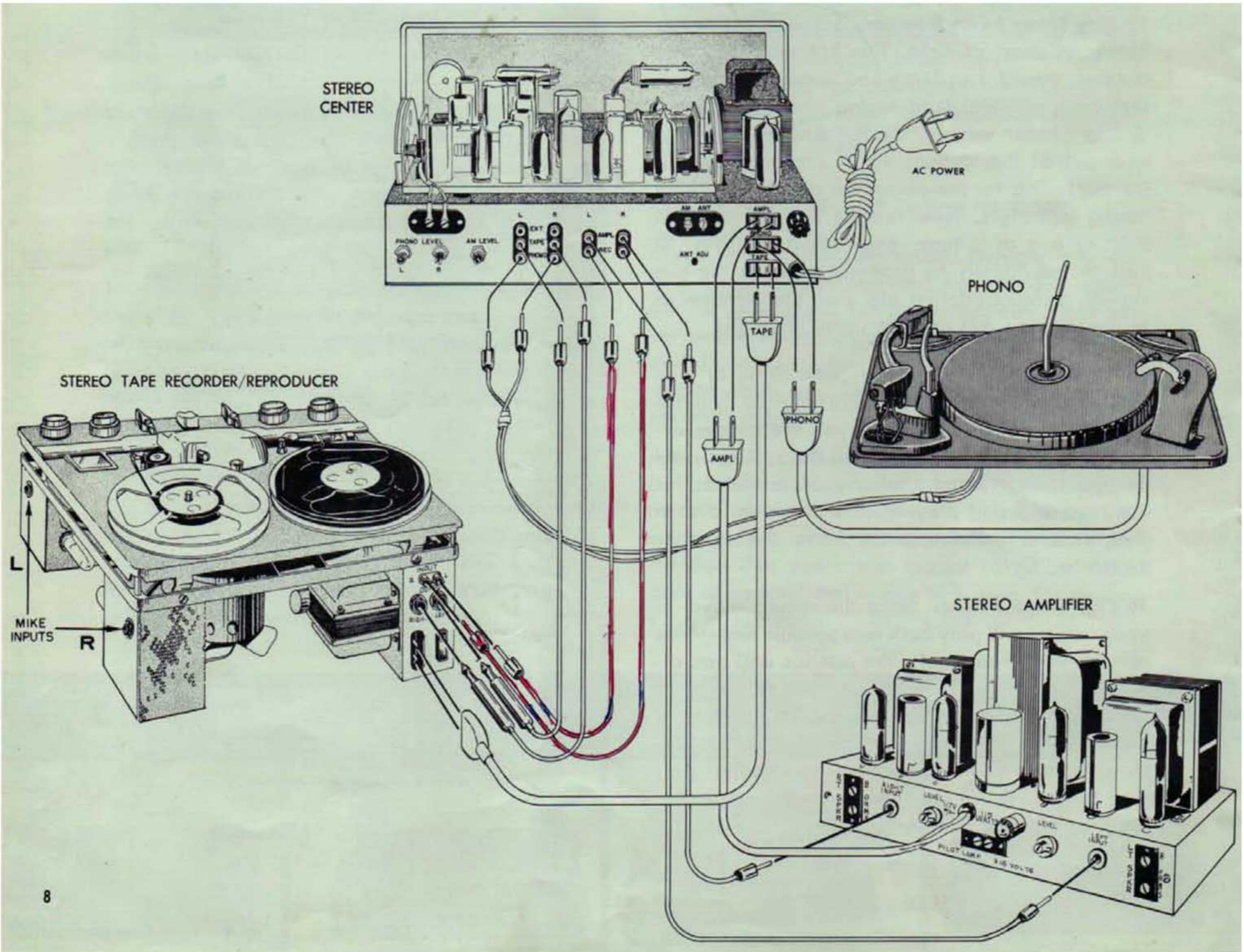
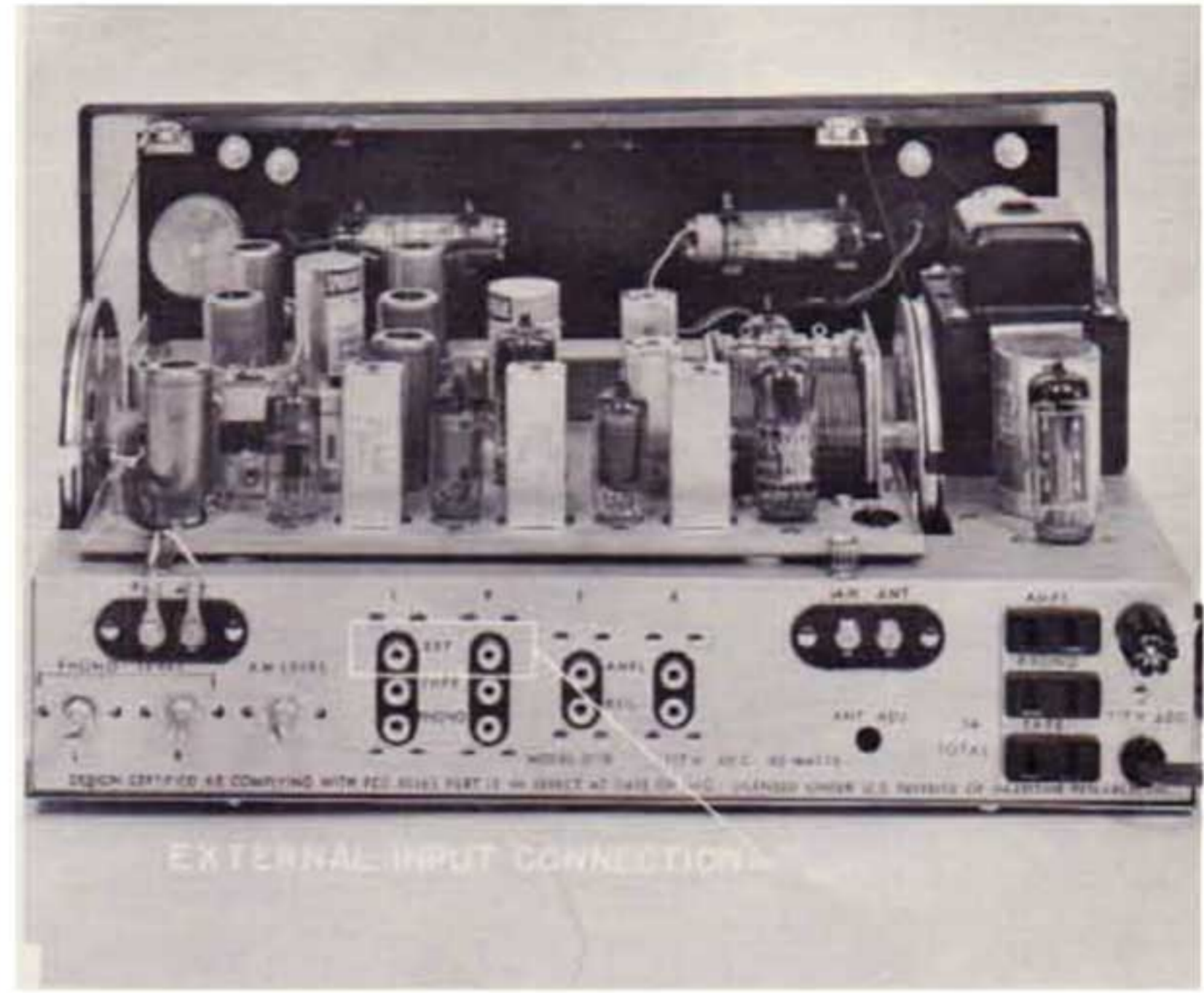

ENGINEERING SPECIFICATIONS

AMPEX STEREO CENTER

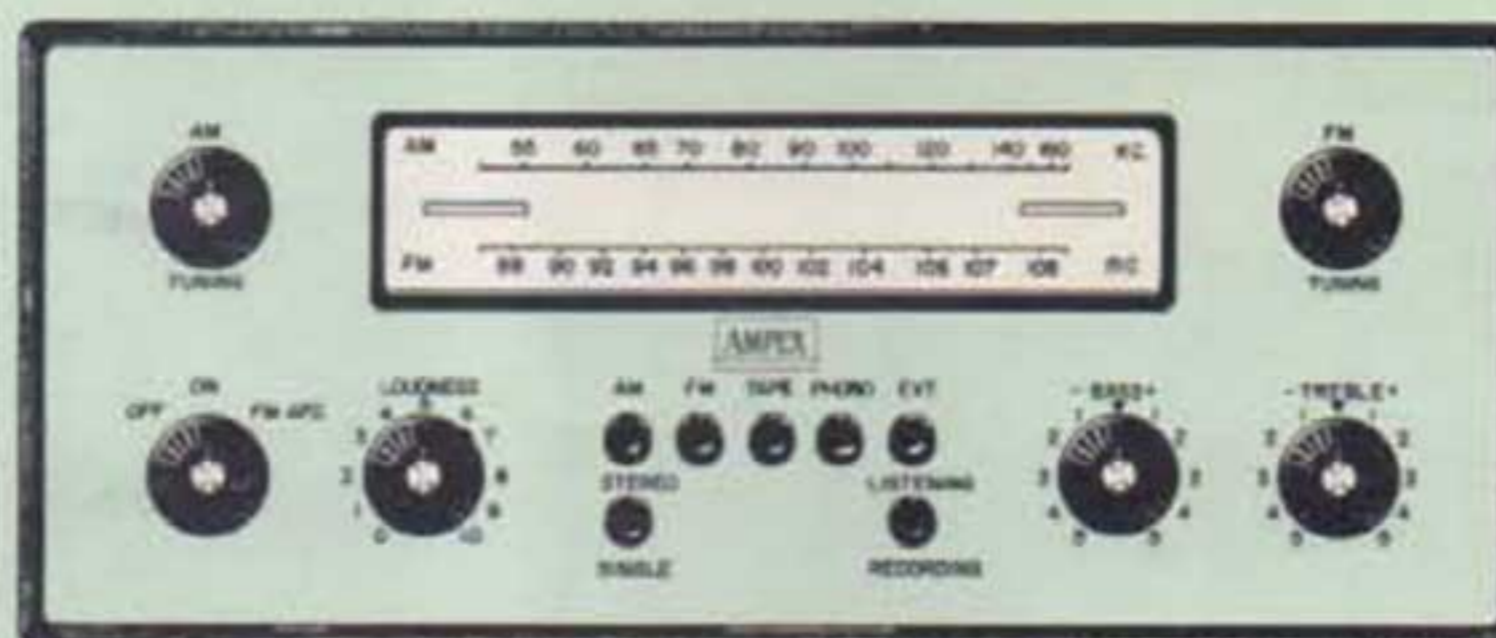

Inputs

4 high level (approximately 200,000 ohms)
2 low level phono (approximately 50,000 ohms)
AM and FM antenna connections
AM ferrite antenna included
FM 300 ohm input.

FM Sensitivity

5 microvolts for 30 db quieting, IHFM Standard.

FM Bandwidth

200 KC.

AM Bandwidth

7.5 KC.

Outputs

2 to power amplifier, 2 to tape recorder RECORD input.

Output Loading

25,000 ohms or greater with less than 2500 mmfd. capacity.

Frequency Response

With 250,000 ohm load —
 ± 2 db from 20 to 20,000 cycles, tone controls in flat position.

Hum and Noise Level

From high level inputs — better than 68 db below 2 volts.
From phono inputs — better than 58 db below 2 volts.

Maximum Gain

From high level inputs to outputs — 0 db.
From phono inputs to outputs — 44 db at 1,000 cycles.

Harmonic Distortion

Less than 0.09% for 1 volt output.

DUAL POWER AMPLIFIER

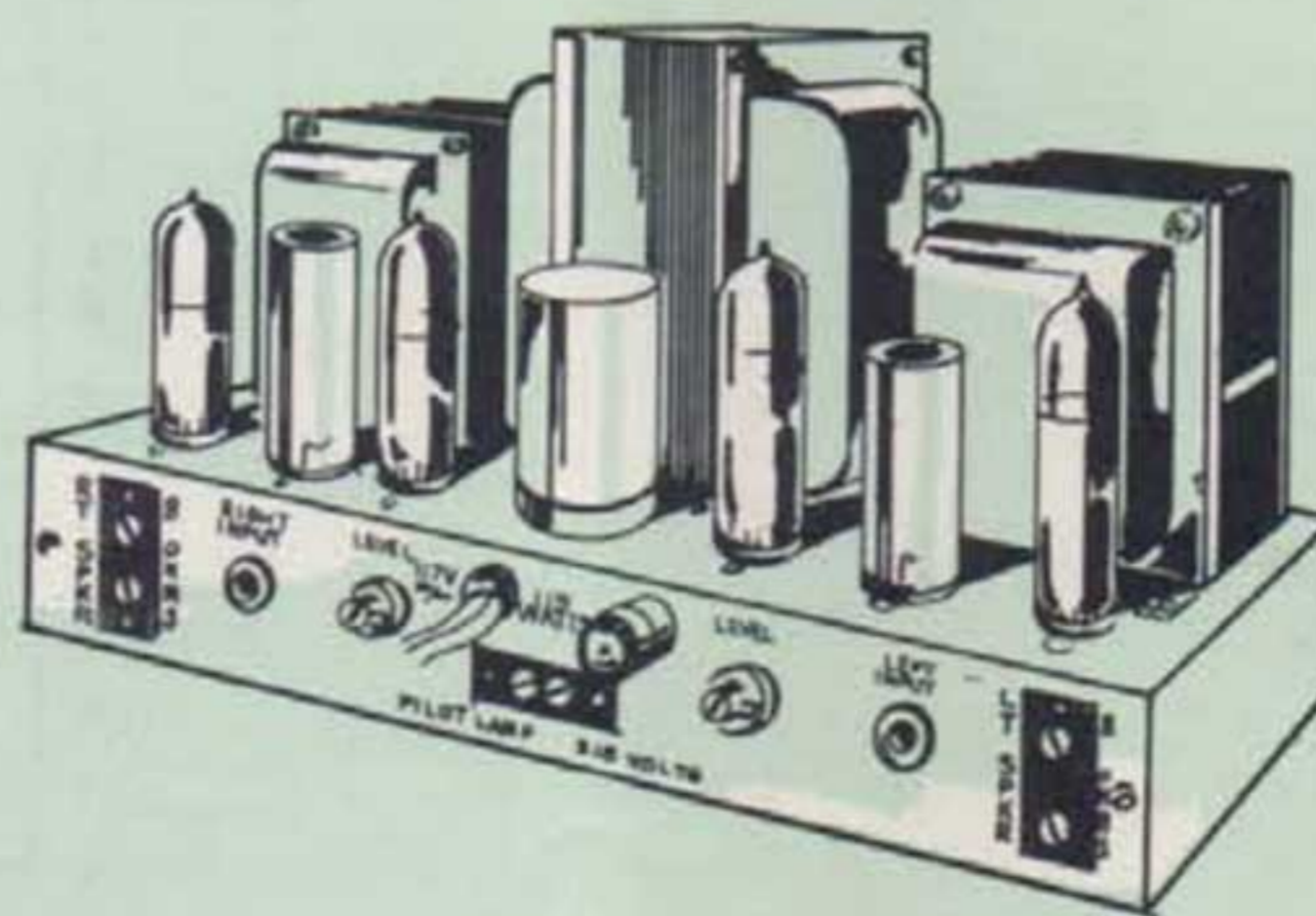

Per channel specifications

Total Harmonic Distortion

Less than 1.0% at rated output.

Frequency Response

± 1 db from 20 cps to 50,000 cps at rated output.

Program Power Output

15 watts; 30 watts peak.

Noise and Hum

78 db below rated output or better.

Input Sensitivity

Less than .80 volts to develop rated power.

STEREO CENTER

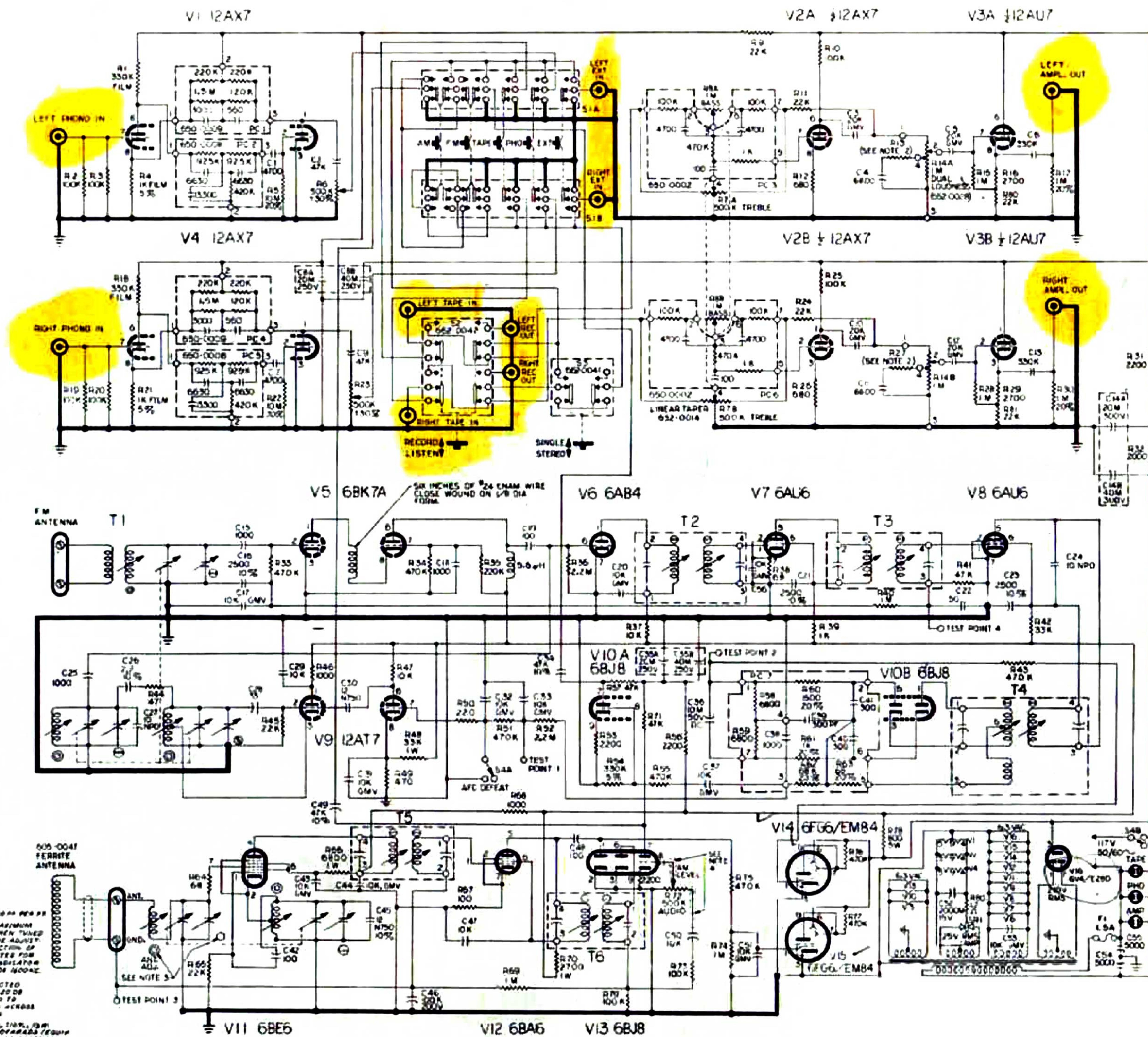

6 REPLACE WITH SHIELDED CABLE OF #30 AWG PER FT

7 ANT. ADJ. SHOULD BE ADJUSTED FOR MAXIMUM CLOSURE OF ANT. TUNING INDICATOR WHEN TUNED TO A STATION AT APPROX. 400 KC. THE ADJUSTABLE TRIMMER CAPACITOR ON RF SECTION OF TUNING CAPACITOR SHOULD BE ADJUSTED FOR MAXIMUM CLOSURE OF ANT. TUNING INDICATOR WHEN TUNED TO A STATION AT APPROX. 1000 KC.

8 R-18 & R-27 ARE RESISTORS OF SELECTED VALUES FROM 20K TO 50K TO YIELD 20 DB ATTENUATION OF A SIGNAL APPLIED TO TERMINALS 1 & 2 WHEN MEASURED ACROSS TERMINALS 3 & 4 OF EACH SECTION

9 ALL RESISTOR VALUES ARE IN OHMS, 100K, 1M, 10M UNLESS OTHERWISE SPECIFIED

NOTE: (UNLESS OTHERWISE SPECIFIED)

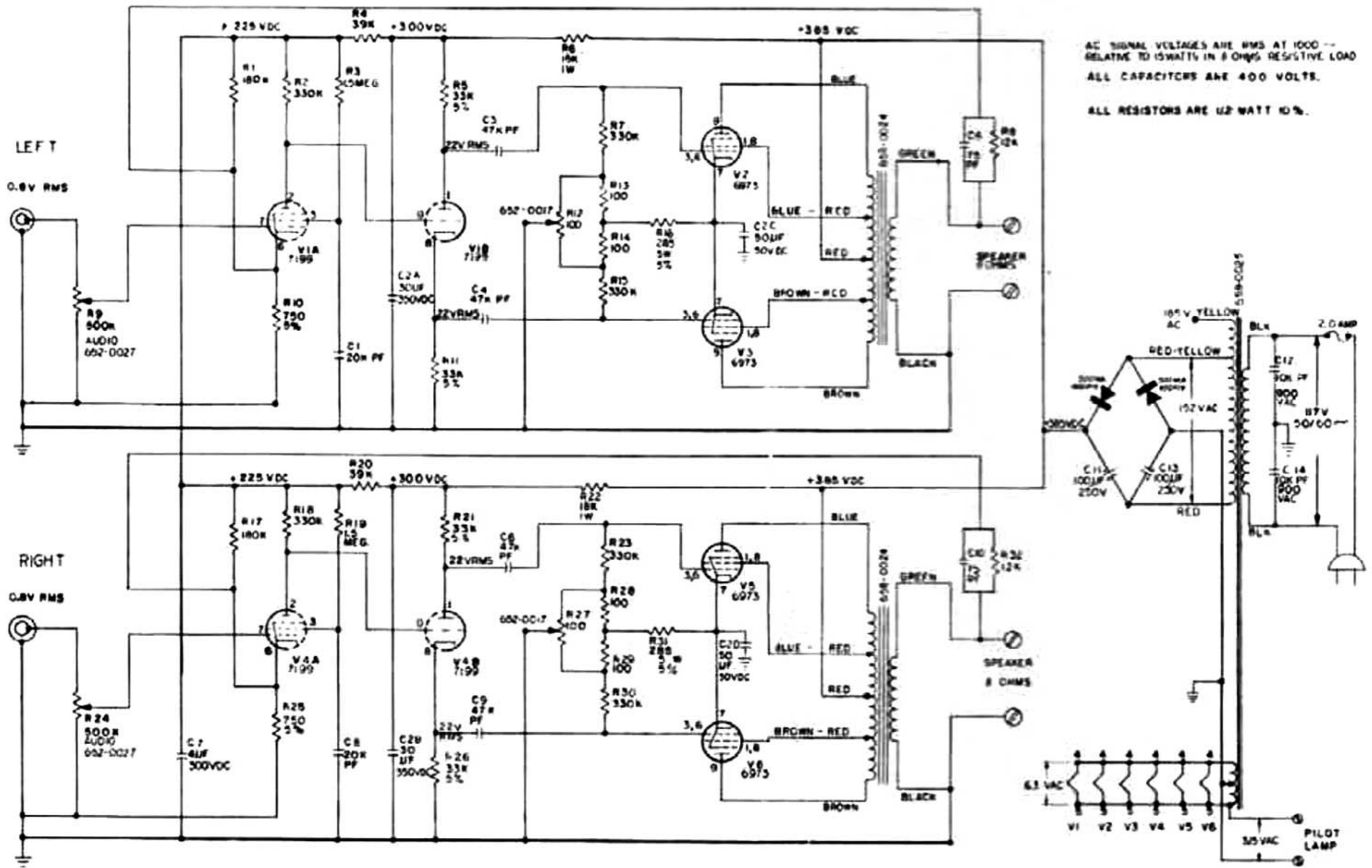

STEREO AMPLIFIER



OWNER'S WARRANTY

WELCOME TO THE GROWING FAMILY OF AMPEX OWNERS. You have purchased one of the finest pieces of equipment of its kind available today. This recorder was accurately adjusted, carefully inspected and thoroughly tested before shipment from the factory and found to meet the recognized high quality standards of Ampex products. If it does not function properly or if there is some question about how it should operate, read your instruction book carefully — you may find that it can be easily corrected.

Ampex Audio Company warrants to the purchaser of each new Ampex recorder-reproducer and/or Amplifier Speaker that any part thereof (with the exception of tubes) which proves to be defective in material or workmanship within ninety (90) days from the date of original purchase for use will be repaired or replaced in accordance with the terms of this warranty.

If any part except tubes should prove to be defective during the aforementioned ninety-day period, such defects should be brought to the attention of the Ampex Audio dealer

from whom the equipment was purchased. If upon examination the part is determined to be defective in material or workmanship, the dealer will replace the defective part at no charge. The responsibility of Ampex Audio Company is limited to making a new or factory-reconditioned replacement part available to the dealer through an Ampex Audio Authorized Service Center. It is the responsibility of the dealer to replace defective parts, either by his own service personnel or through an Ampex Audio Authorized Service Center.

The foregoing is in lieu of all other warranties, expressed, implied or statutory, and Ampex Audio Company neither assumes nor authorizes any person to assume for it any other obligation or liability in connection with said equipment.

THIS WARRANTY IS EFFECTIVE ONLY WHEN ACCOMPANYING CARD IS FULLY AND PROPERLY FILLED OUT AND RETURNED TO FACTORY WITHIN TEN (10) DAYS OF ORIGINAL PURCHASE DATE.

AMPEX